

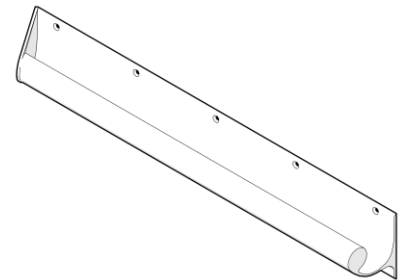

# GalvinCare<sup>®</sup> Anti-Ligature Grab Rails

## PRODUCT CODE:

- |          |          |          |
|----------|----------|----------|
| - 42200* | - 42249* | - 42284* |
| - 42207* | - 42256* | - 42287* |
| - 42235* | - 42271  | - 42290  |
| - 42242* | - 42277  | - 42294  |



## SPECIFICATIONS

- The GalvinCare<sup>®</sup> range of Anti-ligature grab rails provides safe and reliable fixtures for WC's and accessible areas in mental health institutions, psychiatric clinics, hospitals and detention facilities, which helps mitigate the possibility of self-harm by users and patients.

\* Items noted can comply to AS 1428.1-2009 if positioned correctly according to the standard.

## TECHNICAL DATA

<b>Configuration:</b>	Available in lengths up to 6m in length. Can be mitre joined at 30, 45, or 90 degrees
<b>Fixings:</b>	Rails have countersunk fixing points to suit 12G Screw head
<b>Finish:</b>	Powder Coated

**NOTE:** Galvin Specialised continually strive to improve their products. Specifications may change without notice.

## MOUNTING DETAILS

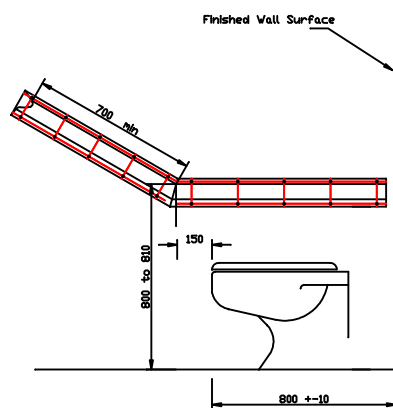

OPTION 1

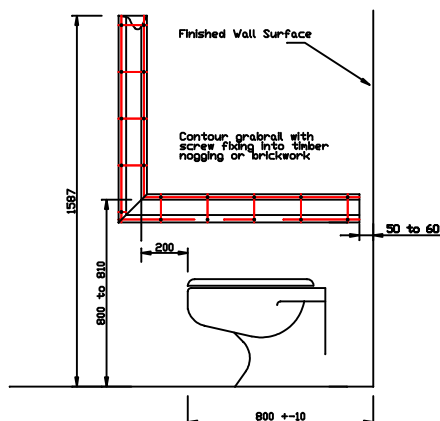

OPTION 2

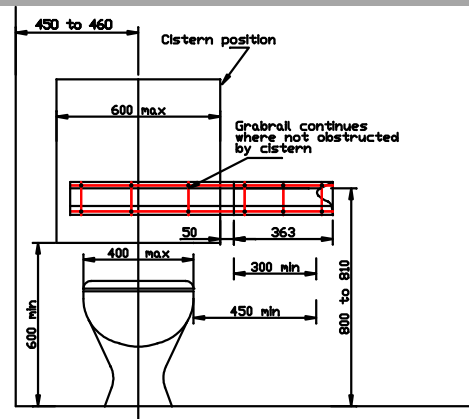

b) Grab rail at back of the pan

### Fixing Requirements

Stainless Steel Security Screws.

- **300mm Grabrail**  
6nr x 12G x 50mm pin hex countersunk self-tapper screws
- **700mm Grabrail**  
8nr x 12G x 50mm pin hex countersunk self-tapper screws
- **900mm Grabrail**  
10nr x 12G x 50mm pin hex countersunk self-tapper screws
- **30 deg Grabrail**  
18nr x 12G x 50mm pin hex countersunk self-tapper screws
- **90 deg Grabrail**  
19nr x 12G x 50mm pin hex countersunk self-tapper screws

a) Sideview showing optional systems for grabrails at the side of the pan.



## Product Installation Guideline

Version 1, 19 November 2019, Page 2 of 3

### INSTALLATION

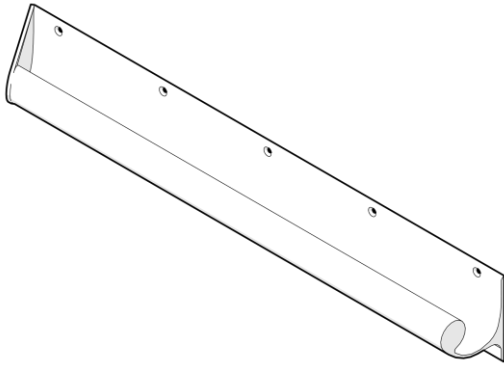

1. Correctly measure position of rail from floor and walls. If required rail can be installed at small fall to allow for easier cleaning and washing.

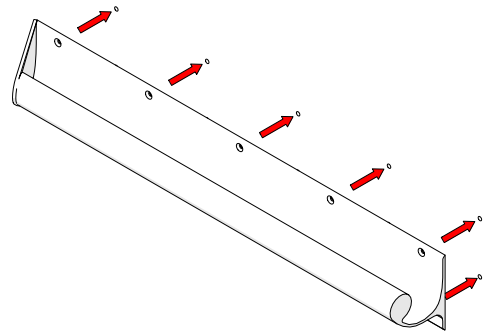

2. Position the rails and mark the position of the holes for fixings. (This may require two people)

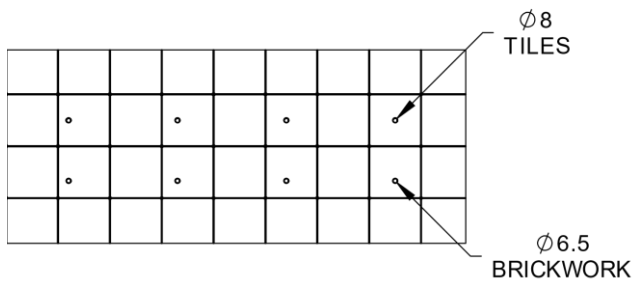

3. If wall tiles have been installed, drill 8mm holes through tiles to reduce the pressure on the tiles and reduce the chances of cracking tiles. Drill 6.5mm holes into brickwork ensuring it is deep enough to take 25mm green plug and 50mm screw.

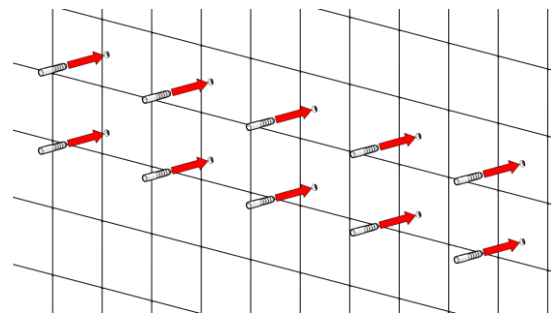

4. Install 25mm green plug into hole and push into hole past the depth of the tiles to prevent any pressure on the wall tiles.

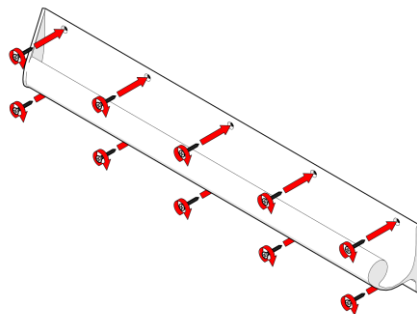

5. Hold rail in position and install required number of 12G x 50mm stainless steel security screws. (Refer to mounting details list for number required).

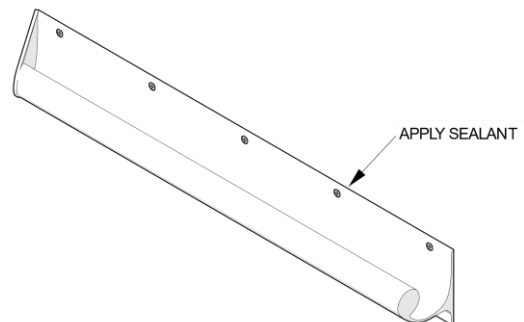

6. The junction between rail and the wall is to be sealed with anti-pick sealant.





## WARRANTY

The warranty set forth herein is given expressly and is the only warranty given by the Galvin Engineering Pty Ltd. With respect to the product, Galvin Engineering Pty Ltd makes no other warranties, express or implied. Galvin Engineering Pty. Ltd. hereby specifically disclaims all other warranties, express or implied, including but not limited to the implied warranties of merchantability and fitness for a particular purpose.

Galvin Engineering Pty Ltd products are covered under our manufacturer's warranty available for download from [www.galvinengineering.com.au](http://www.galvinengineering.com.au) Galvin Engineering Pty Ltd expressly warrants that the product is free from operational defects in workmanship and materials for the warranty period as shown on the schedule in the manufacturer's warranty. During the warranty period, Galvin Engineering will replace or repair any defective products manufactured by Galvin Engineering without charge, so long as the terms of the Manufacturer's warranty are complied with.

The remedy described in the first paragraph of this warranty shall constitute the sole and exclusive remedy for breach of warranty, and Galvin Engineering Pty Ltd shall not be responsible for any incidental, special or consequential damages, including without limitation, lost profits or the cost of repairing or replacing other property which is damaged if this product does not work properly, other costs resulting from labour charges, delays, vandalism, negligence, fouling caused by foreign material, damage from adverse water conditions, chemical, electrical or any other circumstances over which Galvin Engineering has no control. This warranty shall be invalidated by any abuse, misuse, misapplication, improper installation or improper maintenance or alteration of the product.